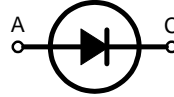
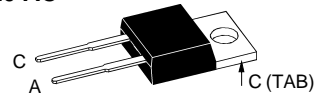

Rectifier Diode

$V_{RRM} = 800-1600\text{ V}$
 $I_{F(AV)M} = 30\text{ A}$

V_{RSM} V	V_{RRM} V	TO-220	TO-263
900	800	DSI 30-08A	DSI 30-08AS
1300	1200	DSI 30-12A	DSI 30-12AS
1500	1400	DSI 30-14A	DSI 30-14AS
1700	1600	DSI 30-16A	DSI 30-16AS

TO-263 AA

TO-220 AC

A = Anode, C = Cathode, TAB = Cathode

Symbol	Conditions	Maximum Ratings	
$I_{F(AV)M}$	$T_C = 95^\circ\text{C}; 180^\circ\text{ sine}$	30	A
I_{FSM}	$T_{VJ} = 45^\circ\text{C}; t = 10\text{ ms (50 Hz), sine}$	300	A
	$V_R = 0\text{ V}; t = 8.3\text{ ms (60 Hz), sine}$	330	A
I^2t	$T_{VJ} = 150^\circ\text{C}; t = 10\text{ ms (50 Hz), sine}$	270	A
	$V_R = 0\text{ V}; t = 8.3\text{ ms (60 Hz), sine}$	300	A
I^2t	$T_{VJ} = 45^\circ\text{C}; t = 10\text{ ms (50 Hz), sine}$	450	A ² s
	$V_R = 0\text{ V}; t = 8.3\text{ ms (60 Hz), sine}$	460	A ² s
T_{VJ}	$T_{VJ} = 150^\circ\text{C}; t = 10\text{ ms (50 Hz), sine}$	365	A ² s
	$V_R = 0\text{ V}; t = 8.3\text{ ms (60 Hz), sine}$	380	A ² s
T_{VJM}		-40...+150	°C
T_{stg}		150	°C
M_d	Mounting torque	0.4...0.6	Nm
Weight		2	g

Features

- International standard packages
- JEDEC TO-263 AA surface mountable
- Planar passivated chips
- Epoxy meets UL 94V-0 flammability classification

Symbol	Conditions	Characteristic Values	
I_R	$T_{VJ} = T_{VJM}; V_R = V_{RRM}$	≤ 1	mA
V_F	$I_F = 45\text{ A}; T_{VJ} = 25^\circ\text{C}$	≤ 1.45	V
V_{T0}	For power-loss calculations only	0.85	V
r_T	$T_{VJ} = T_{VJM}$	13	mΩ
R_{thJC}	DC current	1.0	K/W

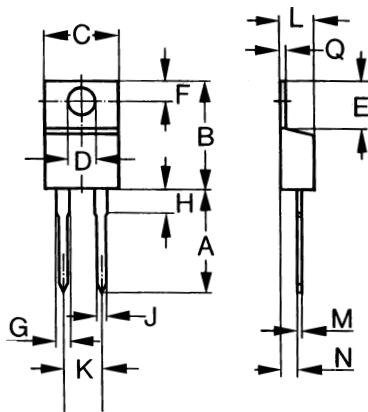
TO-220 Outline

Dim.	Millimeter		Inches	
	Min.	Max.	Min.	Max.
A	12.70	14.73	0.500	0.580
B	14.23	16.51	0.560	0.650
C	9.66	10.66	0.380	0.420
D	3.54	4.08	0.139	0.161
E	5.85	6.85	0.230	0.420
F	2.54	3.42	0.100	0.135
G	1.15	1.77	0.045	0.070
H	-	6.35	-	0.250
J	0.64	0.89	0.025	0.035
K	4.83	5.33	0.190	0.210
L	3.56	4.82	0.140	0.190
M	0.38	0.56	0.015	0.022
N	2.04	2.49	0.080	0.115
Q	0.64	1.39	0.025	0.055

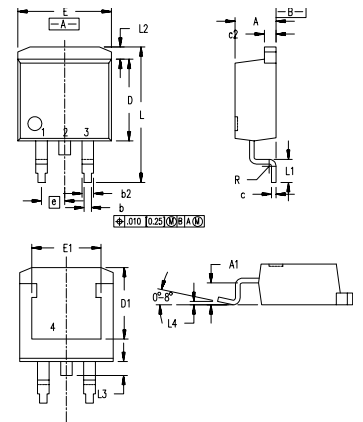
TO-263 AA Outline

Dim.	Millimeter		Inches	
	Min.	Max.	Min.	Max.
A	4.06	4.83	.160	.190
A1	2.03	2.79	.080	.110
b	0.51	0.99	.020	.039
b2	1.14	1.40	.045	.055
c	0.46	0.74	.018	.029
c2	1.14	1.40	.045	.055
D	8.64	9.65	.340	.380
D1	7.11	8.13	.280	.320
E	9.65	10.29	.380	.405
E1	6.86	8.13	.270	.320
e	2.54	BSC	.100	BSC
L	14.61	15.88	.575	.625
L1	2.29	2.79	.090	.110
L2	1.02	1.40	.040	.055
L3	1.27	1.78	.050	.070
L4	0	0.38	0	.015
R	0.46	0.74	.018	.029

Data according to IEC 60747 and refer to a single diode
 IXYS reserves the right to change limits, test conditions and dimensions

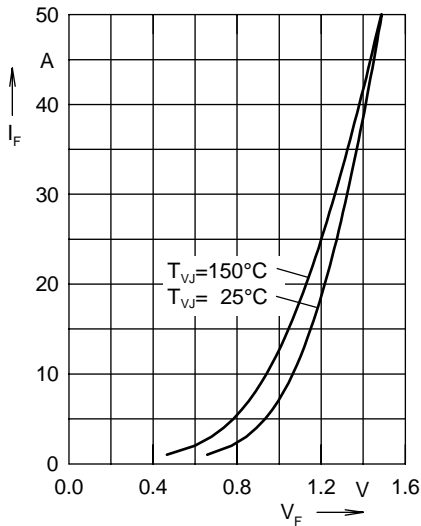

Fig. 1 Forward current versus voltage drop per diode

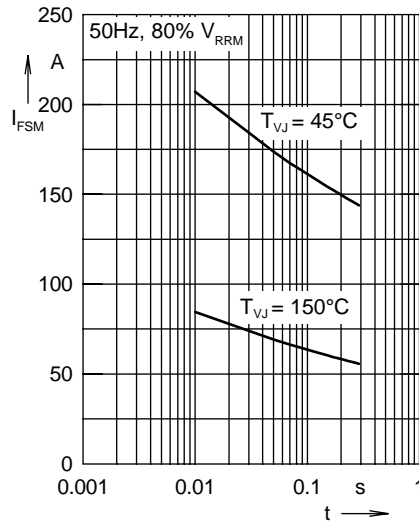

Fig. 2 Surge overload current

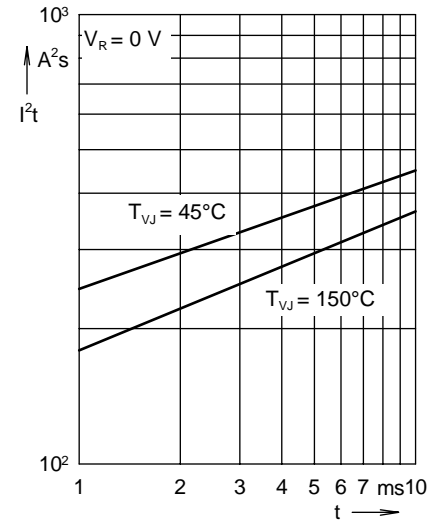

Fig. 3 I^2t versus time per diode

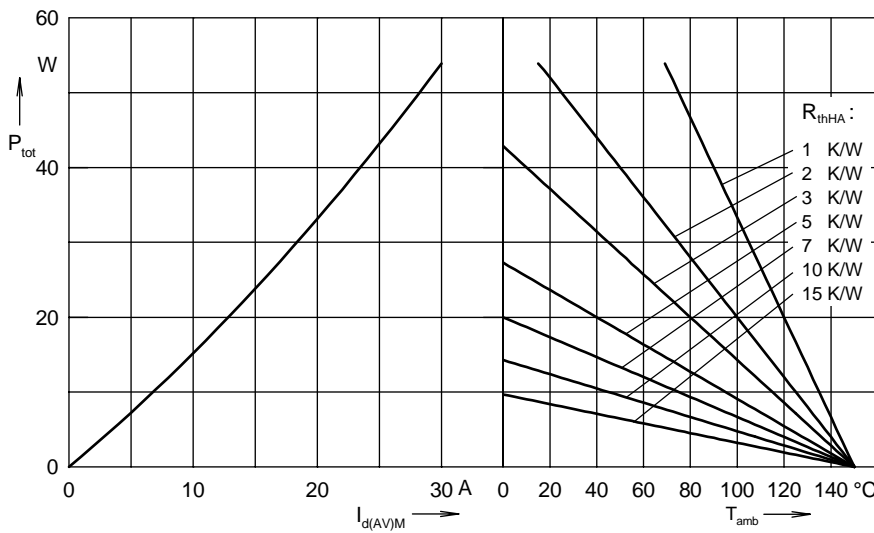

Fig. 4 Power dissipation versus direct output current and ambient temperature, sine 180°

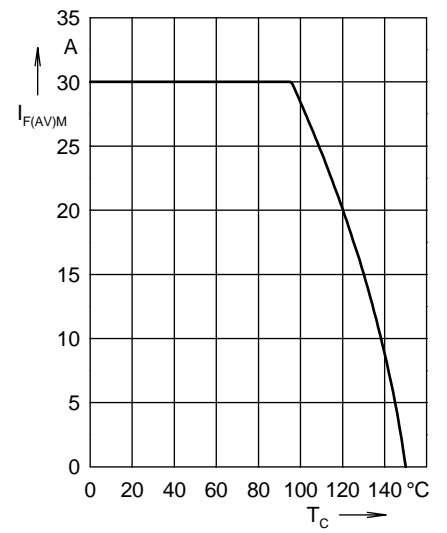

Fig. 5 Max. forward current versus case temperature

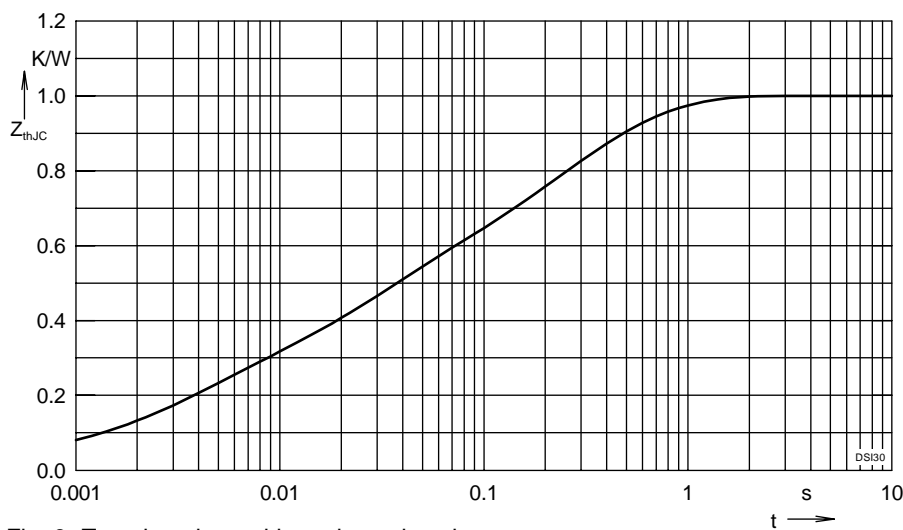

Fig. 6 Transient thermal impedance junction to case

Constants for Z_{thJC} calculation:

i	R_{thi} (K/W)	t_i (s)
1	0.01362	0.0001
2	0.1962	0.00316
3	0.267	0.023
4	0.3052	0.4
5	0.218	0.15